

## BALCONY II

LFM5168



**MADE IN  
FRANCE**



---

**Important** : à conserver pour de futurs besoins de références, à lire attentivement.

**Important** : keep this manual for future reference, please read carefully.

**Wichtig** : Bitte diese Anleitung für den späteren Gebrauch aufheben und sie aufmerksam lesen.

**Belangrijk** : Te bewaren voor later gebruik, aandachtig lezen.

**Importante** : da conservare per esigenze future di riferimento, da leggere attentamente.

**Importante** : consérverse para futuras necesidades de referencia, léase atentamente.

---

Ce produit est destiné à un usage domestique - This product is designed for domestic use  
Dieses Produkt ist für den Hausgebrauch bestimmt - Dit product is bedoeld voor huishoudelijk gebruik  
Questo apparecchio è destinato a un utilizzo domestico - Este producto está destinado a un uso doméstico

---

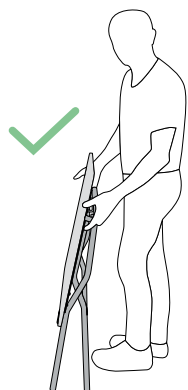
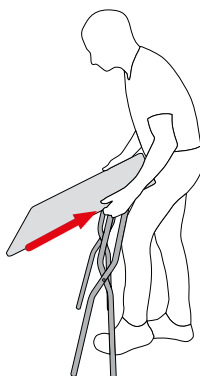
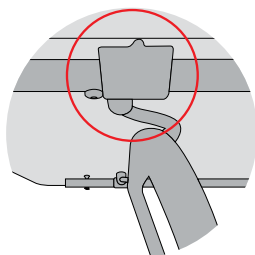
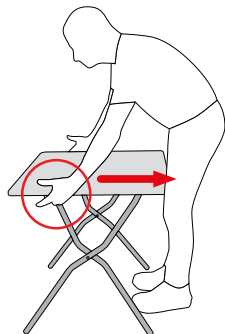
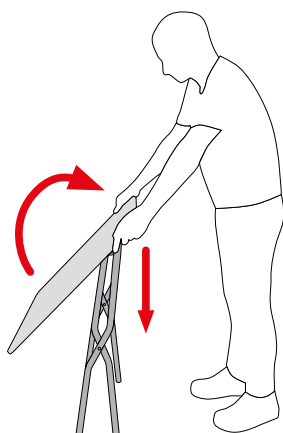
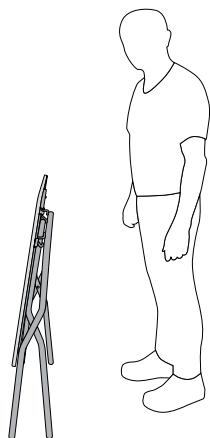

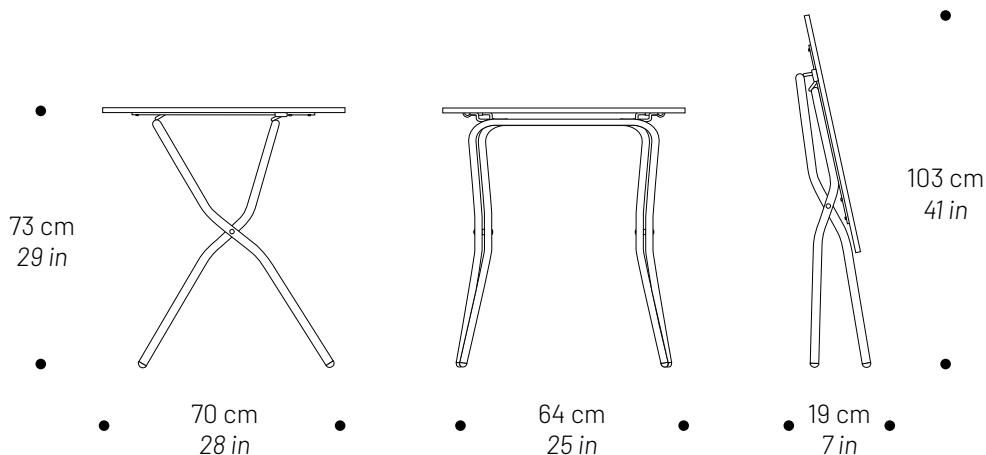

1  
POSITION

10,2  
Kg

ACIER  
GALVANISÉ  
GALVANIZED  
STEEL  
plateau  
tabletop

ACIER  
STEEL  
piétement  
support legs

#### FR - Instructions d'entretien / maintenance

Nettoyage de la structure: nettoyer régulièrement à l'eau savonneuse à l'aide d'une éponge, **côté non abrasif**. Afin de prolonger la durée de vie du produit, nous vous recommandons de protéger votre mobilier avec la **Housse de protection Relax & BALCONY II LAFUMA MOBILIER**.

#### ENG - Care/maintenance instructions

Cleaning frame: clean regularly with soapy water, using the **non-abrasive side** of a sponge. In order to prolong the lifespan of the product, we recommend you protect your furniture with the **LAFUMA MOBILIER Reclining chairs & BALCONY II protective cover**.

#### DE - Anweisungen zur Pflege / Instandhaltung

Reinigung des Gestells: Regelmäßig mit Seifenwasser und einem Schwamm reinigen, der nicht scheuert. Um die Lebensdauer des Produktes zu verlängern, empfehlen wir Ihnen, Ihre Möbel mit der **LAFUMA MOBILIER Schutzhülle für Relax und BALCONY II** zu schützen.

#### NL - Onderhoudsinstructies

Het reinigen van het frame: Maak regelmatig schoon met zeepwater en een spons (**gebruik de niet-schurende kant**). Om de levensduur van het product te verlengen, raden wij u aan uw meubelen te beschermen met de **LAFUMA MOBILIER Relaxstoelen & BALCONY II beschermhoes**.

#### IT - Istruzioni per la cura / manutenzione

Pulizia della struttura: pulire regolarmente con acqua e sapone utilizzando una spugna **dal lato non abrasivo**. Per prolungare la durata di vita del prodotto, vi consigliamo quindi di proteggere il vostro mobile con la **custodia di protezione Relax e BALCONY II LAFUMA MOBILIER**.

#### ES - Instrucciones de mantenimiento

Limpieza de la estructura: limpiar, de manera regular, con agua y jabón y con la ayuda de una esponja, **por el lado no abrasivo**. Con el fin de prolongar la vida útil del producto, le aconsejamos que proteja el mobiliario con la **funda de protección Relax y BALCONY II LAFUMA MOBILIER**.

# Lafuma<sup>®</sup>

MOBILIER

## LAFUMA MOBILIER SAS

6 rue Victor Lafuma - 26140 ANNEYRON

Tél. +33 (0)4 75 31 31 31

[lafuma-mobilier.com](http://lafuma-mobilier.com)



Imprimé sur papier recyclé - Printed on recycled paper



FR

Donnez ou recyclez  
vos meubles.



Association

ou



Magasin

ou



Déchèterie



<https://quefairedevosdechets.fr>

261953