

VENCE table low - 102 x 59 cm

LFM5281

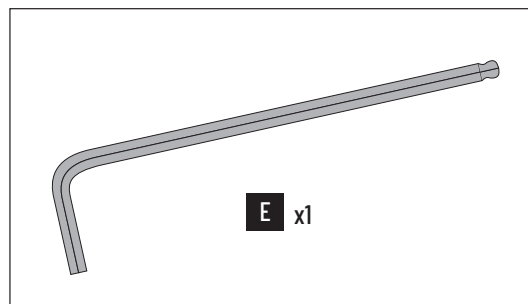

**MADE IN
FRANCE**

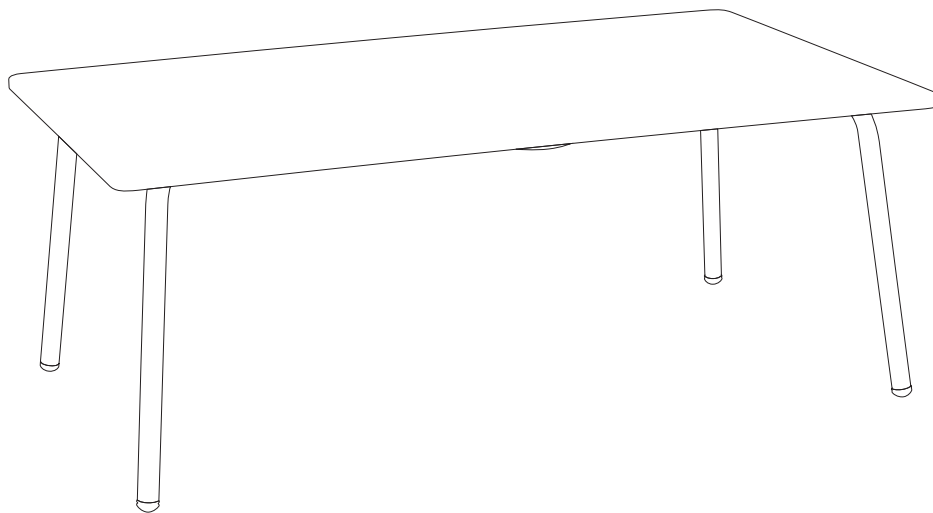

Important : à conserver pour de futurs besoins de références, à lire attentivement.

Important : keep this manual for future reference, please read carefully.

Wichtig : Bitte diese Anleitung für den späteren Gebrauch aufheben und sie aufmerksam lesen.

Belangrijk : Te bewaren voor later gebruik, aandachtig lezen.

Importante : da conservare per esigenze future di riferimento, da leggere attentamente.

Importante : conservar para futuras necesidades de referencia, léase atentamente.

Usage domestique (garantie 5 ans) - Usage collectif (garantie 2 ans) / Domestic use (5-year warranty) - Collective use (2-year warranty)
Häuslicher Gebrauch (5 Jahre Garantie) - Gemeinschaftlicher Gebrauch (2 Jahre Garantie) / Huishoudelijk gebruik (5 jaar garantie) - Collectief gebruik (2 jaar garantie)
Usso domestico (5 anni di garanzia) - Uso collettivo (2 anni di garanzia) / Uso doméstico (5 años de garantía) - Uso colectivo (2 años de garantía)

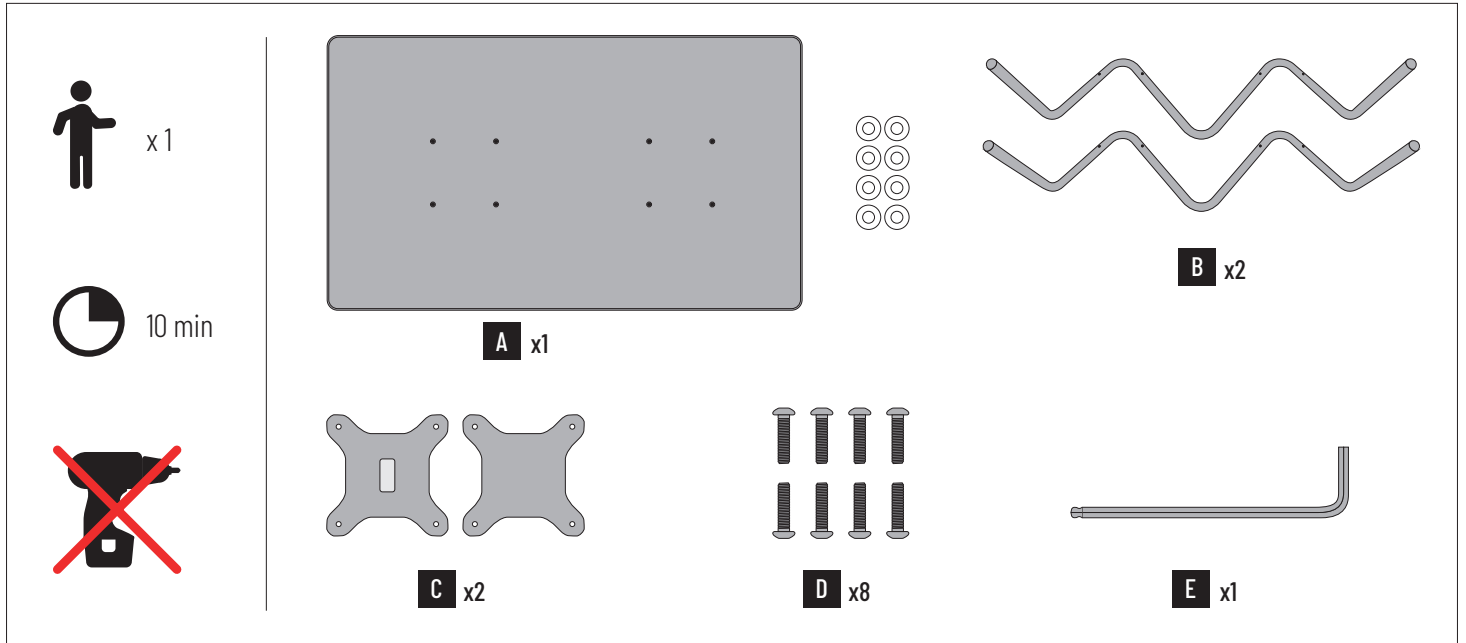

1 A C E

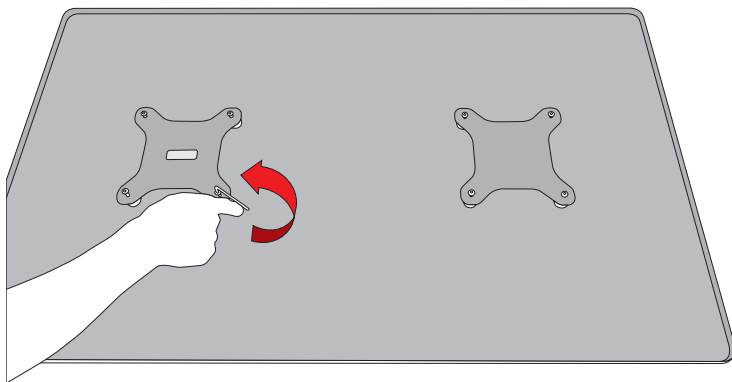

2 A

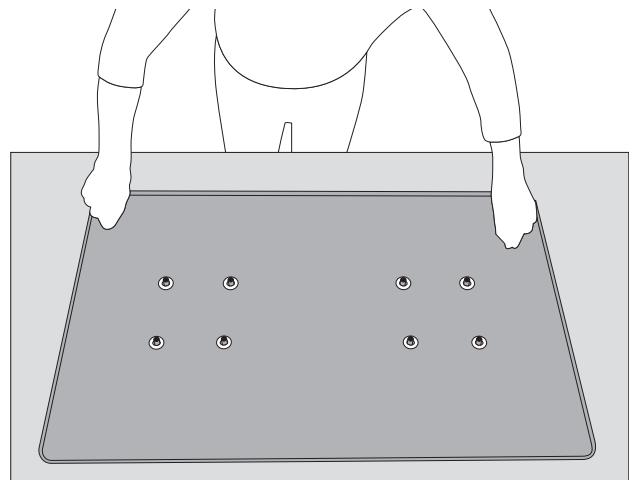

3 B

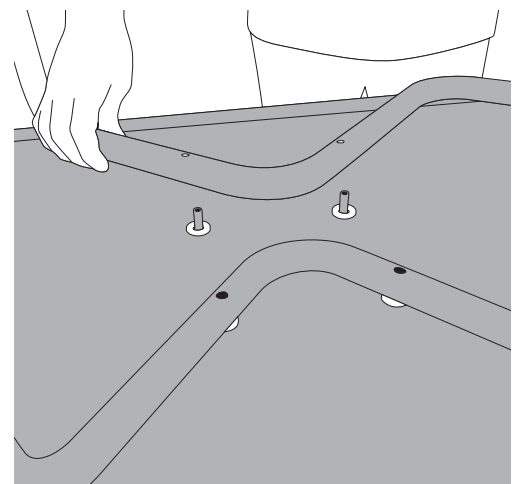
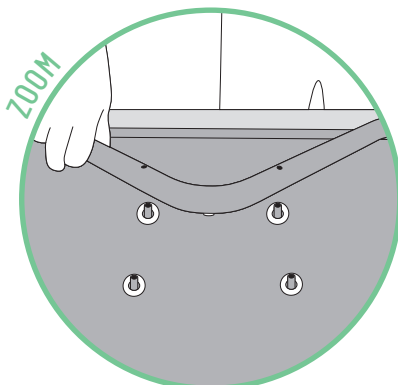
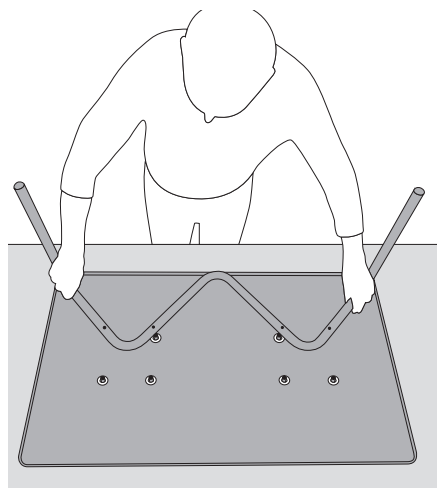

4

A B C

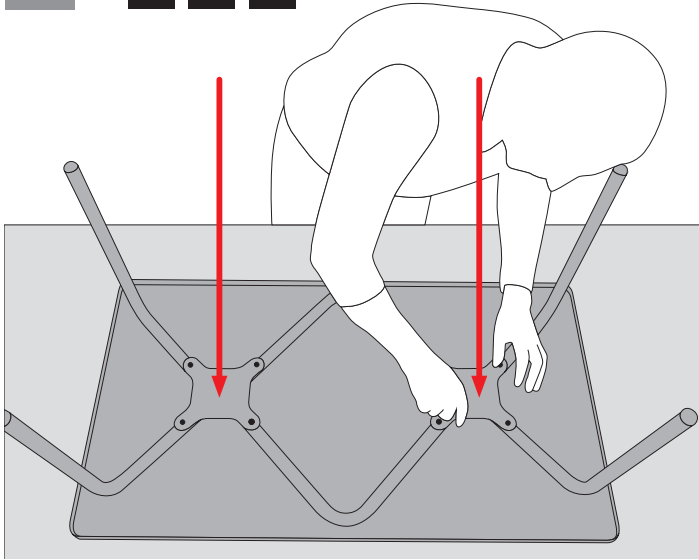

5

C D E x8

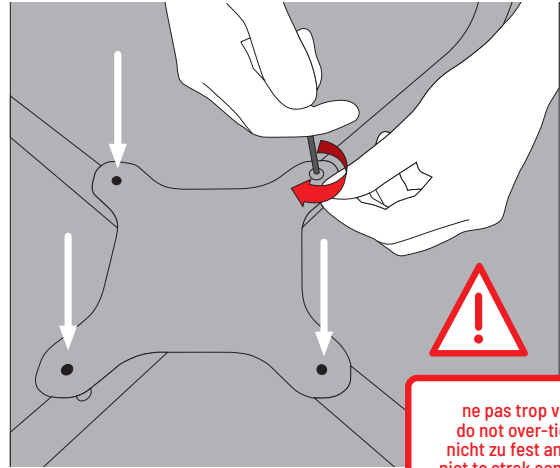

ne pas trop visser
do not over-tighten
nicht zu fest anziehen
niet te strak aandraaien
non stringere troppo
no apriete demasiado

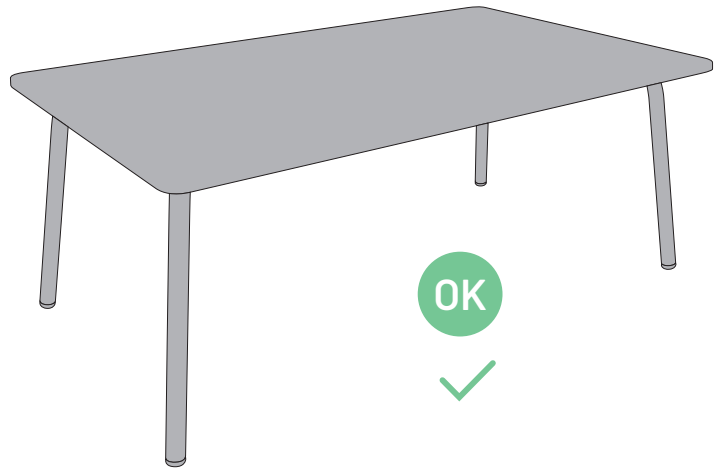
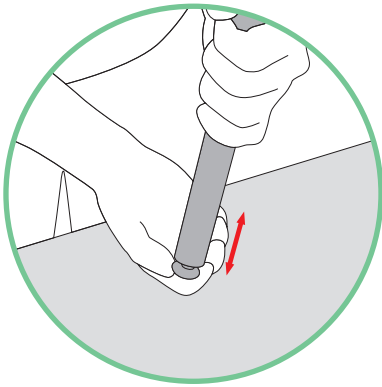
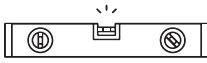

40 cm
15.7 in

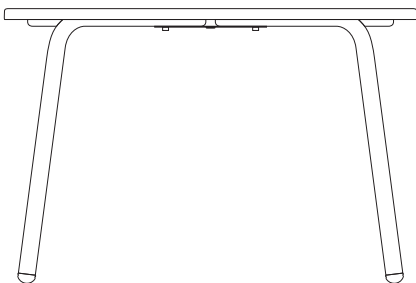

59 cm
23.2 in

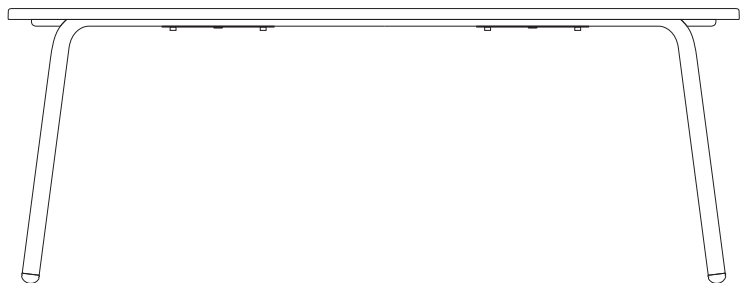

102 cm
40.2 in

1
POSITION

11,3
Kg

ACIER
STEEL

FR - Instructions d'entretien / maintenance

Pour l'entretien de votre mobilier nous vous conseillons de nettoyer à l'eau savonneuse votre table après chaque utilisation à l'aide d'une éponge **coté non abrasif** (ne pas utiliser de produits à base d'acide, de vinaigre et de chlore). Afin de prolonger la durée de vie de la table, nous vous conseillons de protéger votre mobilier lorsque vous ne l'utilisez pas.

ENG - Care/maintenance instructions

For cleaning your furniture we recommend you wash the table with soapy water after each use, using the **non-abrasive side** of a sponge (do not use products based on acid, vinegar or chlorine). In order to prolong the lifespan of your table, we recommend you protect your furniture when it is not in use.

DE - Anweisungen zur Pflege / Instandhaltung

Zur Pflege Ihrer Möbel empfehlen wir Ihnen, Ihren Tisch nach jedem Gebrauch mit Seifenwasser und der nicht scheuernden Seite eines Schwamms zu reinigen (keine säurehaltigen Produkte, Essig oder Chlor verwenden). Um die Lebensdauer des Tisches zu verlängern, empfehlen wir Ihnen, Ihre Möbel zu schützen, wenn Sie sie nicht benutzen.

NL - Onderhoudsinstructies

Om je meubels te onderhouden, raden we je aan om de tafel na elk gebruik schoon te maken met zeepwater en een spons, met de **niet-schurende kant** (gebruik geen producten op basis van zuur, azijn of chloor). Om de levensduur van de tafel te verlengen, raden wij u aan uw meubelen te beschermen wanneer ze niet worden gebruikt.

IT - Istruzioni per la cura / manutenzione

Per la manutenzione del tavolo, si consiglia di pulirlo con acqua e sapone dopo ciascun utilizzo, utilizzando una spugna **dal lato non abrasivo** (non utilizzare prodotti a base di acido, aceto e cloro). Per prolungare la durata di vita del tavolo, vi consigliamo quindi di proteggere il vostro mobile se non lo utilizzate.

ES - Instrucciones de mantenimiento

Le recomendamos que utilice agua con un poco de jabón y una esponja no abrasiva para limpiar la mesa después de cada uso (no utilice ácido, vinagre ni productos a base de cloro). Con el fin de prolongar la vida útil de la mesa, le aconsejamos que proteja el mobiliario cuando no vaya a usarlo.

Lafuma[®] 
MOBILIER

LAFUMA MOBILIER SAS

6 rue Victor Lafuma - 26140 ANNEYRON

Tél. +33 (0)4 75 31 31 31

lafuma-mobilier.com



Imprimé sur papier recyclé - Printed on recycled paper



FR

Donnez ou recyclez
vos meubles.



Association

ou



Magasin

ou



Déchèterie



<https://quefairedemesdechets.fr>